

KERATWIN K20 - KLAMMER

NICHT SICHTBARE BEFESTIGUNG MIT KLAMMERN K20
INVISIBLE FASTENING WITH CLAMP K20
FIXATION NON APPARANTE PAR AGRAFE K20

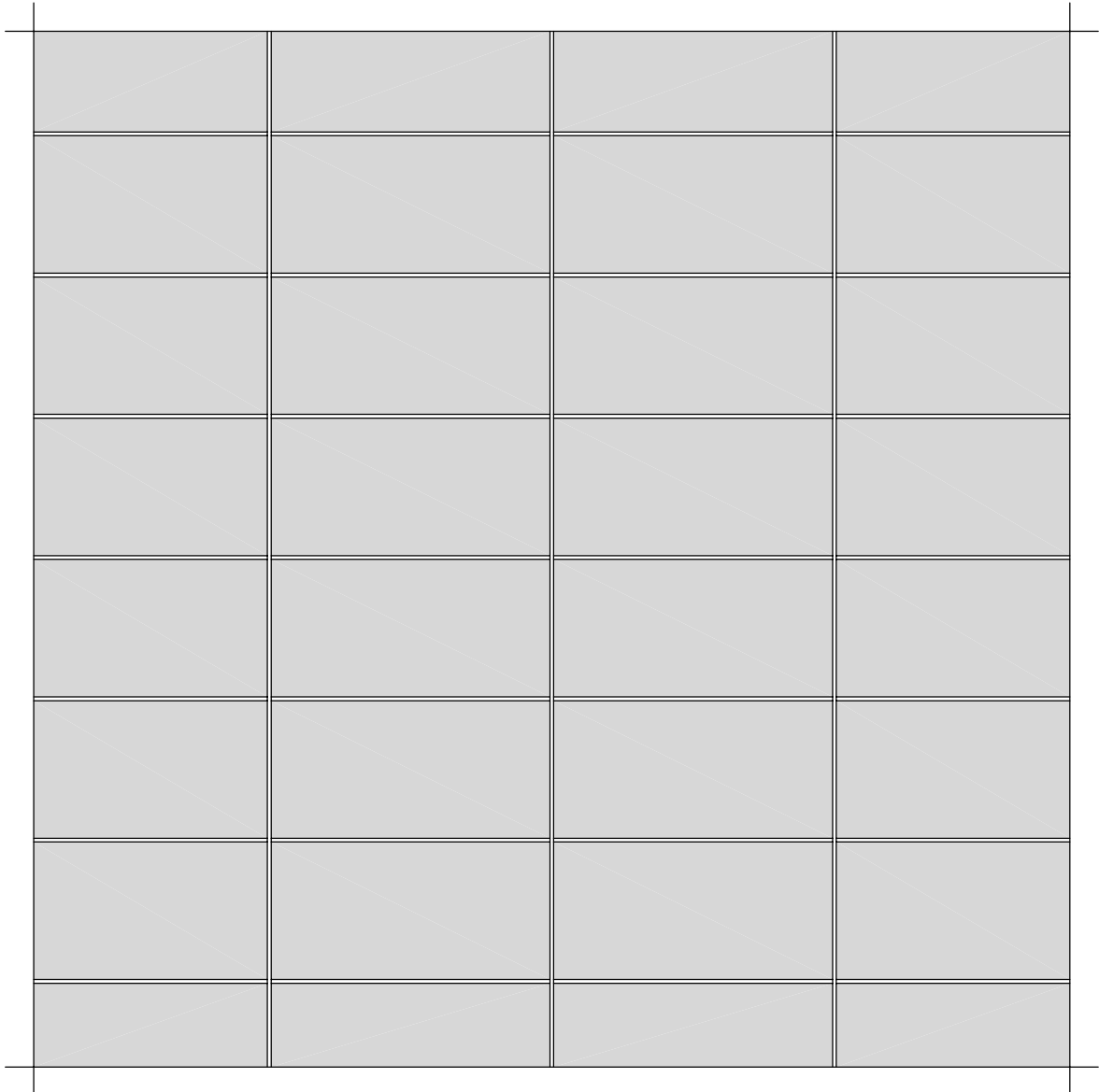

WEITERE OBJEKTSPEZIFISCHE DETAILS AUF ANFRAGE
FURTHER PROJECT-RELATED DETAILS UPON REQUEST
D'AUTRES DETAILS RELATIFS AU PROJET SUR DEMANDE

SYSTEMÜBERSICHT

SYSTEM SCHEME

SYSTEME - VUE D' ENSEMBLE

KERATWIN K20 - KLAMMER

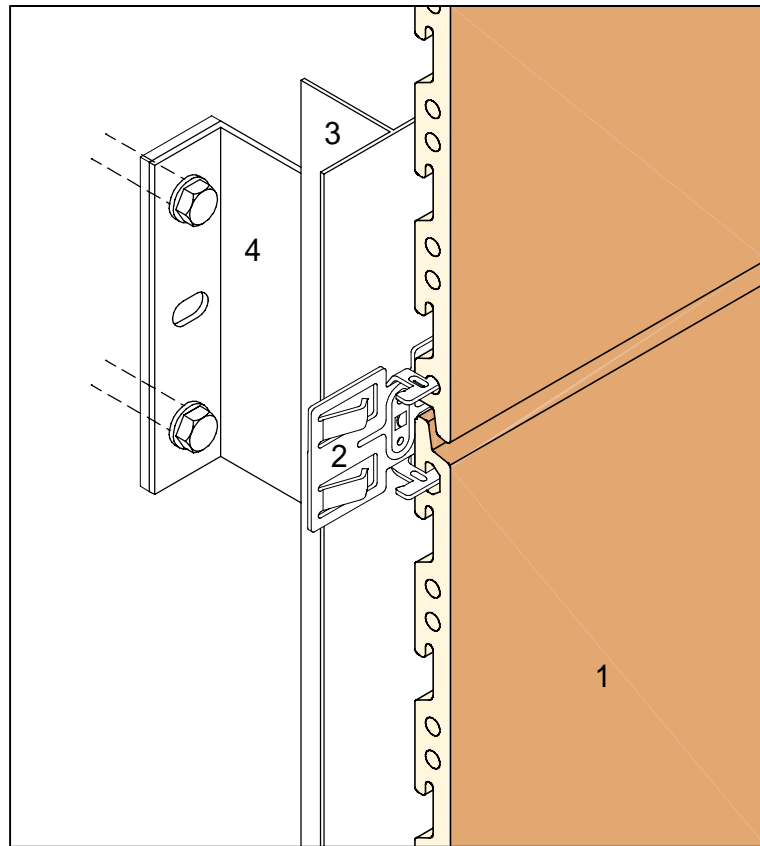

- 1 - KERATWIN K20 - FASSADENPLATTE
- 2 - BEFESTIGUNGSKLAMMER SYSTEM K20
- 3 - VERTIKALES TRAGPROFIL
- 4 - ALUMINIUM-WANDHALTER

- 1 - KERATWIN K20 - PANEL
- 2 - FASTENING CLAMP SYSTEM K20
- 3 - VERTICAL BEARING PROFILE
- 4 - ALUMINIUM WALL BRACKET

- 1 - DALLE KERATWIN K20
- 2 - AGRAFE DE FIXATION SYSTEME K20
- 3 - PROFILE PORTEUR VERTICAL
- 4 - PIECE DE SUPPORT MURAL EN ALUMINIUM

SYSTEMSCHNITT HORIZONTAL

HORIZONTAL SECTION
COUPE HORIZONTALE

KERATWIN K20 - KLAMMER

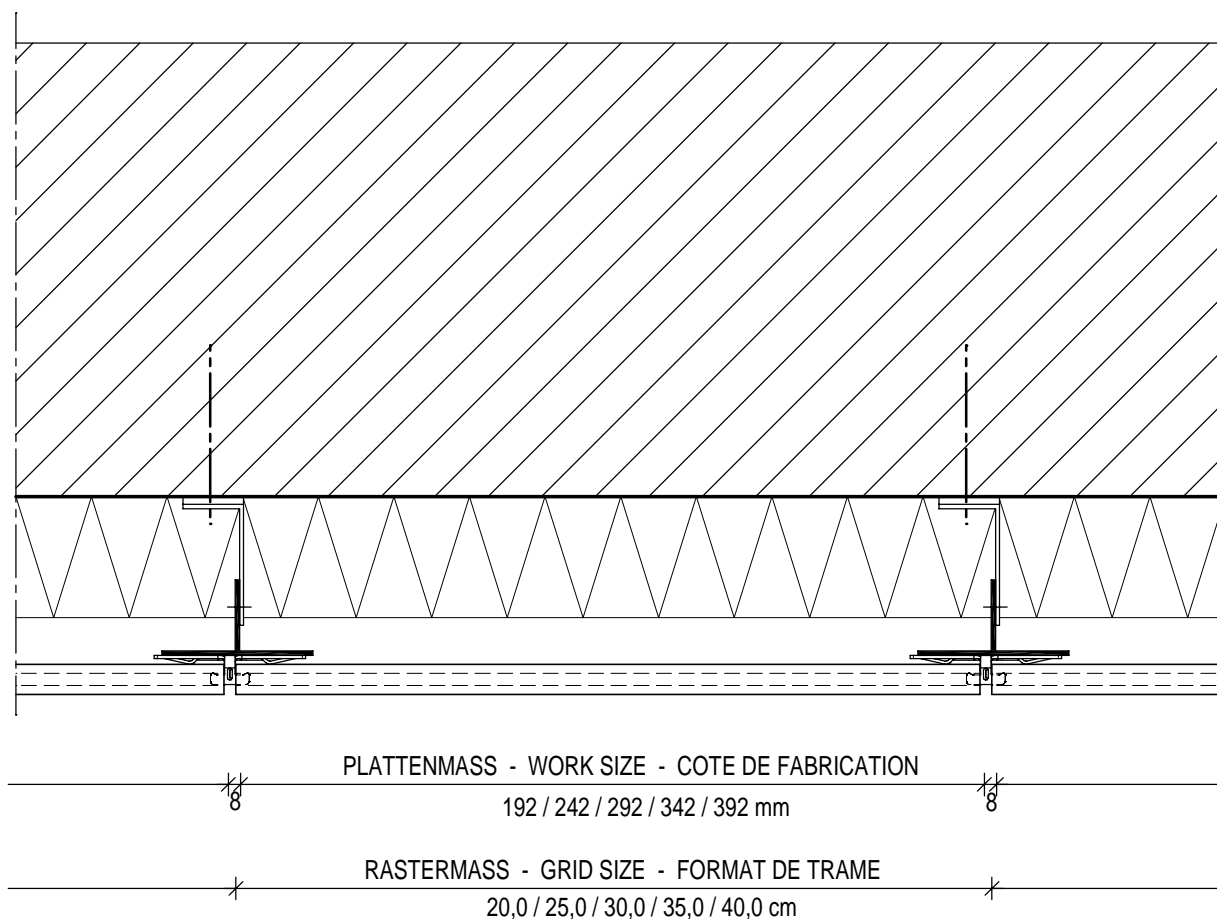

SYSTEMSCHNITT VERTIKAL

VERTICAL SECTION
COUPE VERTICALE

KERATWIN K20 - KLAMMER

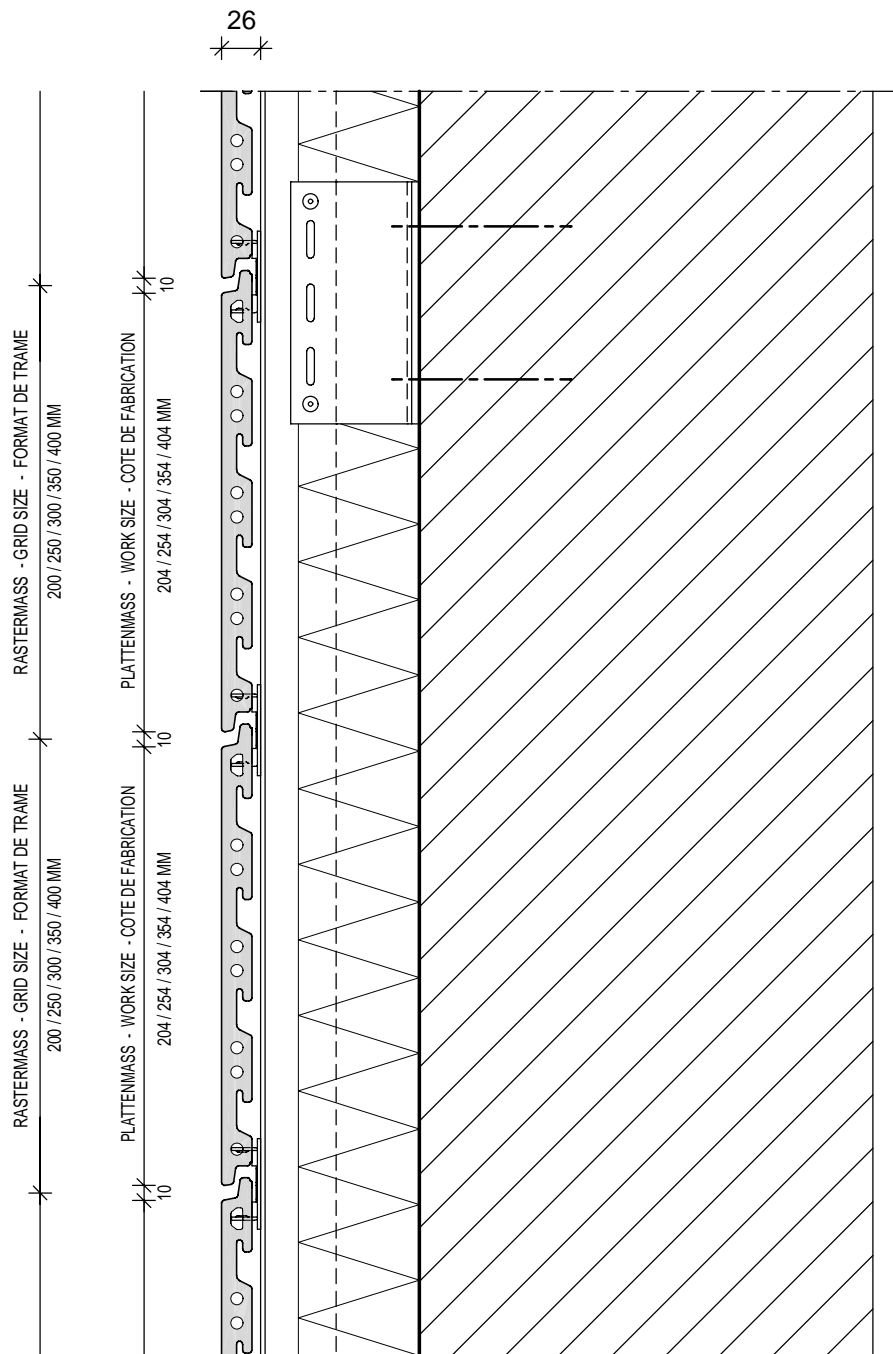

PROFILSTOSS

BUTT-JOINT OF PROFILES
BOUT DE PROFILE

KERATWIN K20 - KLAMMER

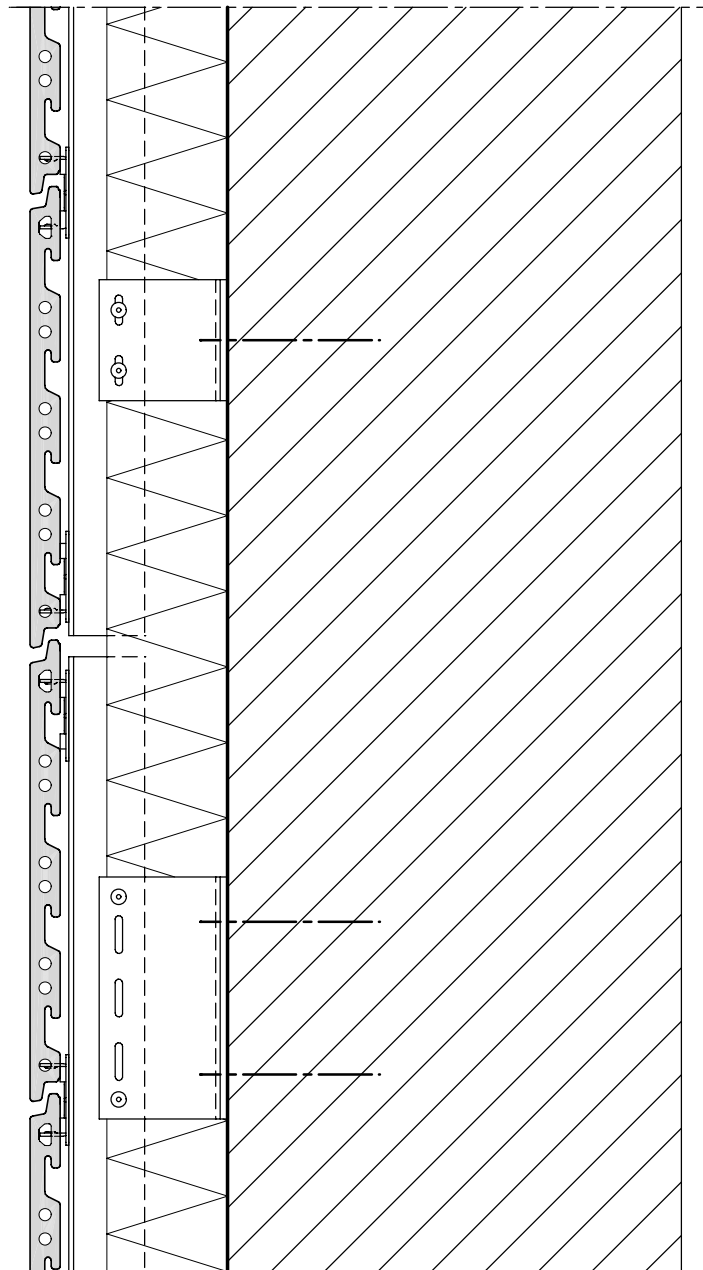

AUSSENECKE MIT GEHRUNGSPLATTEN

EXTERNAL ANGLE WITH MITRED TILES

ANGLE EXTERIEUR AVEC CARREAUX EN BIAIS

KERATWIN K20 - KLAMMER

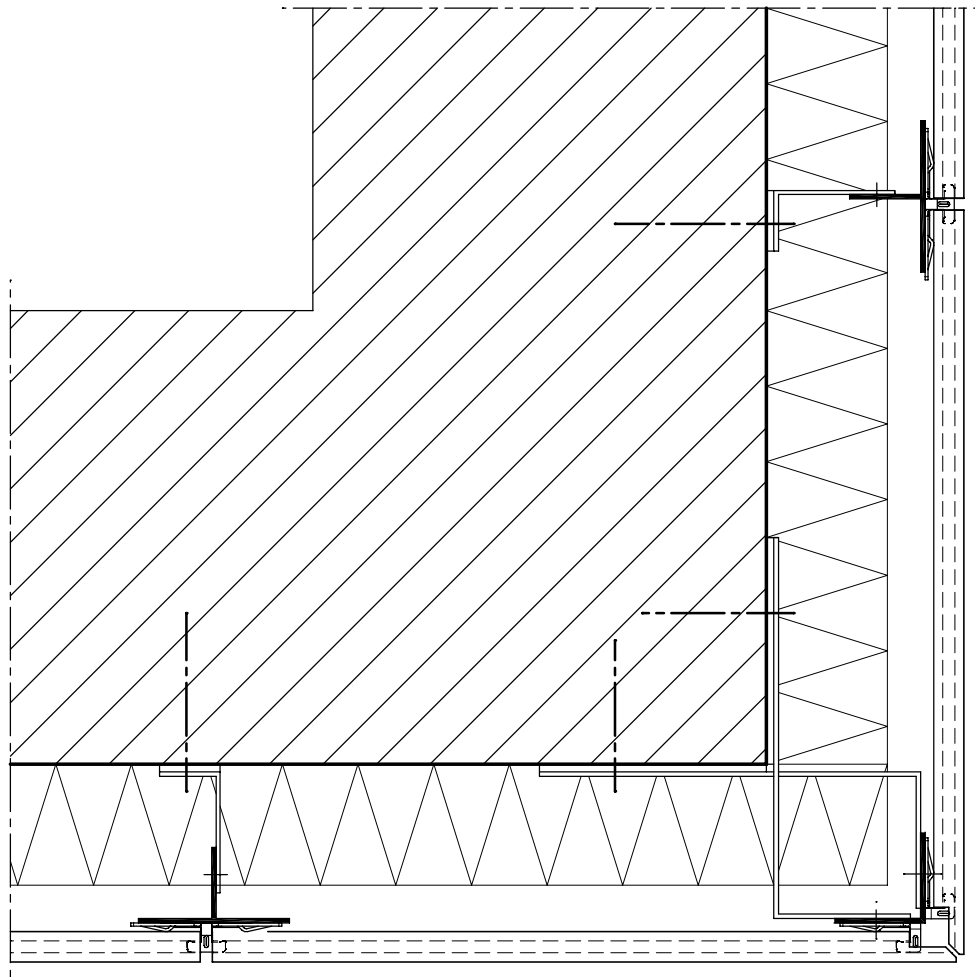

AUSSENECKE MIT NEGATIVECKE

EXTERNAL ANGLE WITH NEGATIVE CORNER PROFILE
ANGLE EXTERIEUR AVEC PROFILE D' ANGLE NEGATIF

KERATWIN K20 - KLAMMER

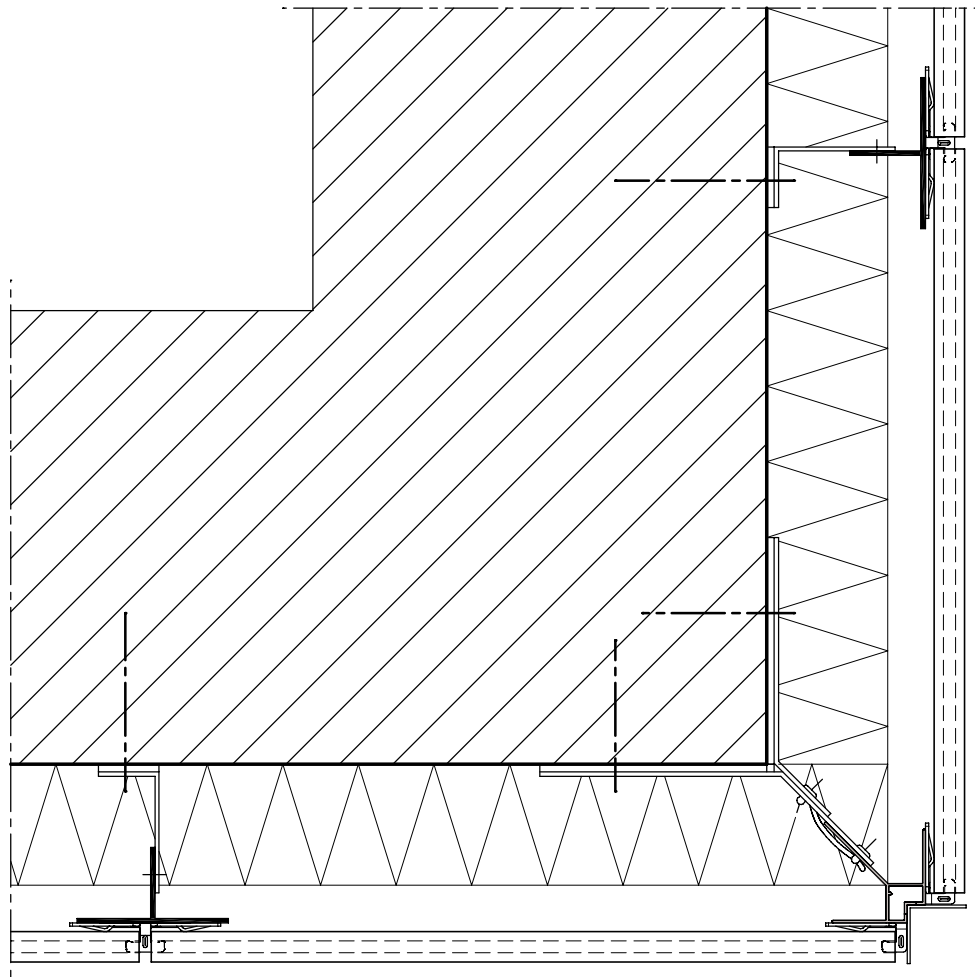

SOCKELANSCHLUSS

CONNECTION TO PLINTH
RACCORD DE SOCLE

KERATWIN K20 - KLAMMER

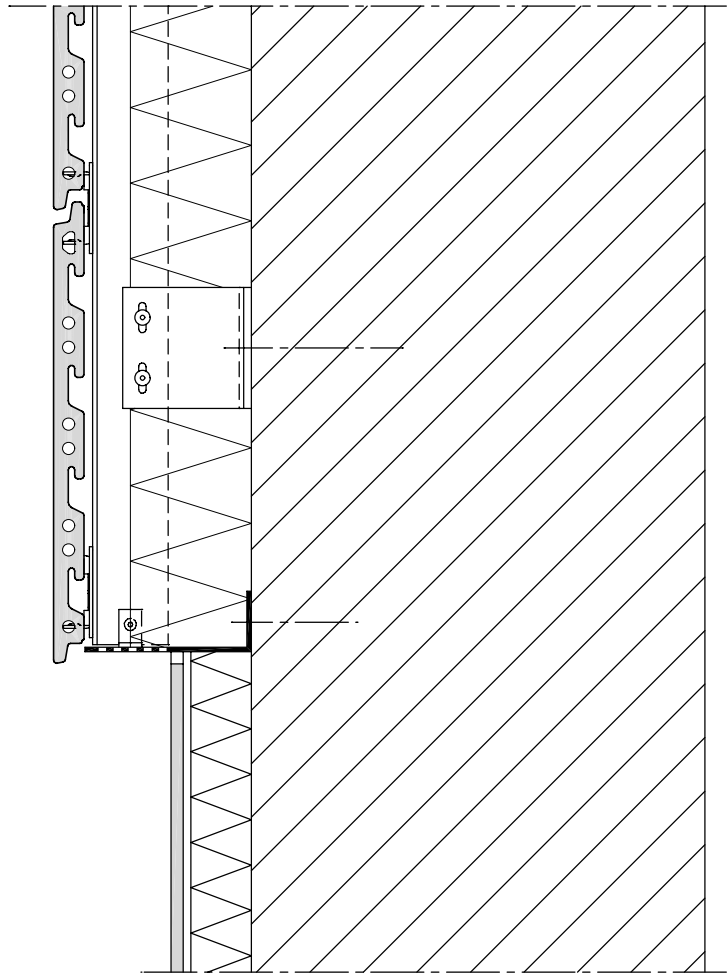

FENSTERSTURZ

WINDOW LINTEL

LINTEAU DE LA FENETRE

KERATWIN K20 - KLAMMER

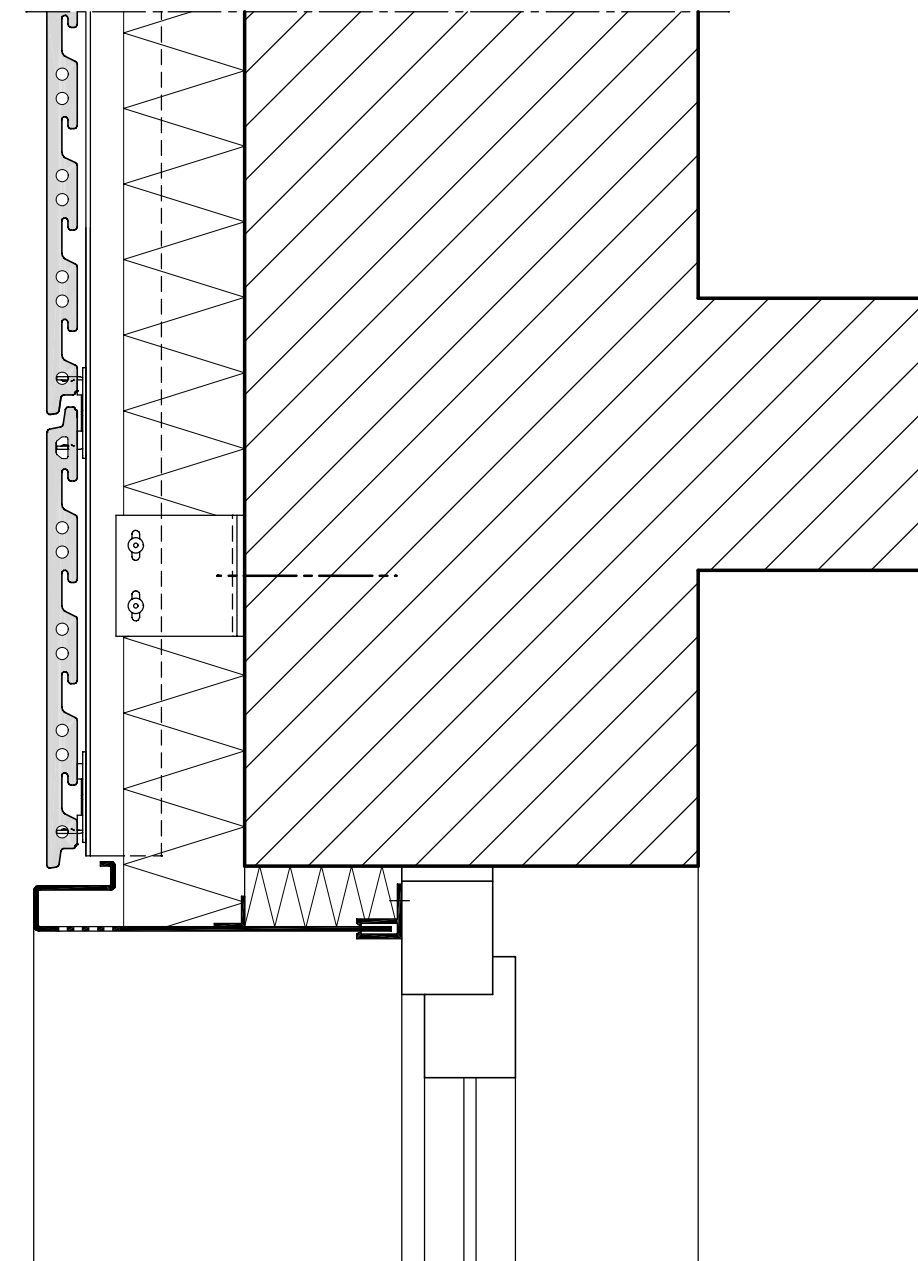

FENSTERBANK

WINDOW SILL
APPUI DE FENETRE

KERATWIN K20 - KLAMMER

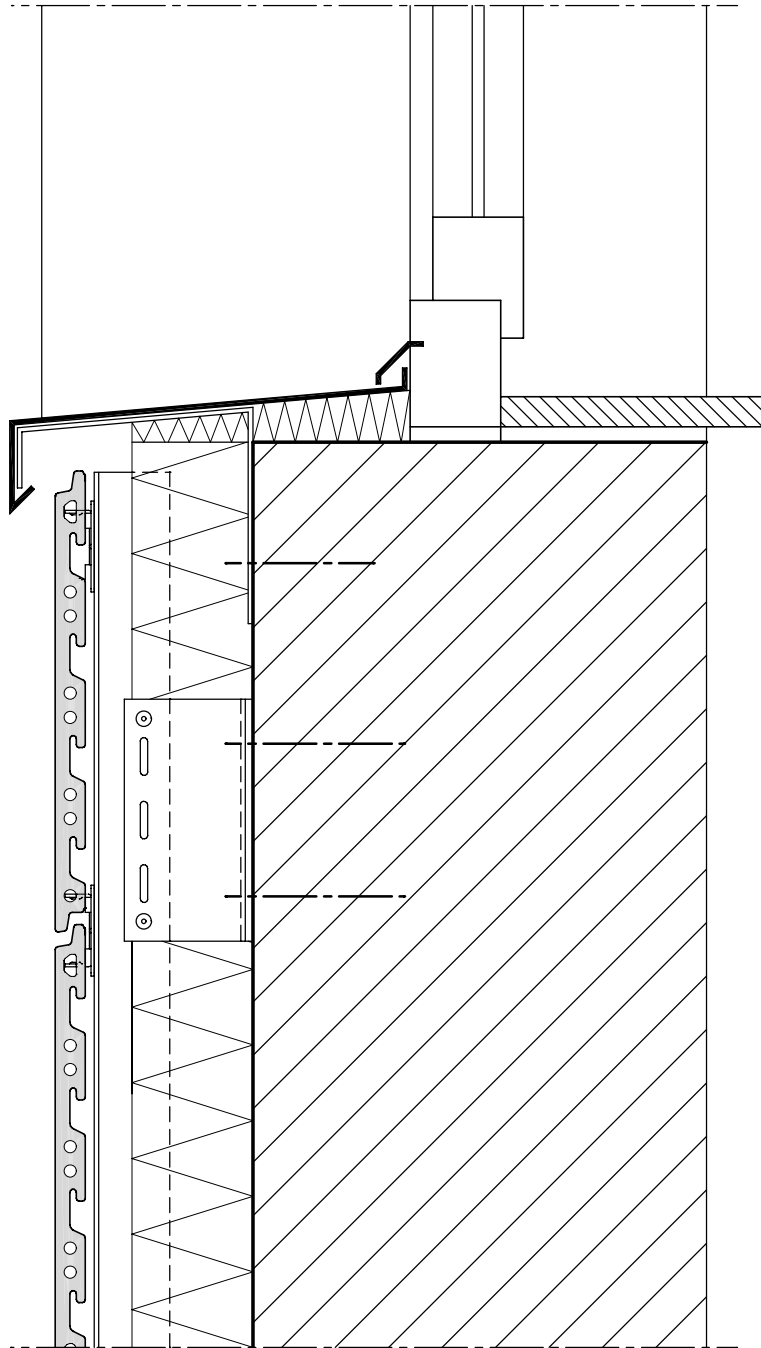

FENSTERLEIBUNG MIT BLECH

EMBRASURE OF THE WINDOW
EMBRASURE DE FENETRE

KERATWIN K20 - KLAMMER

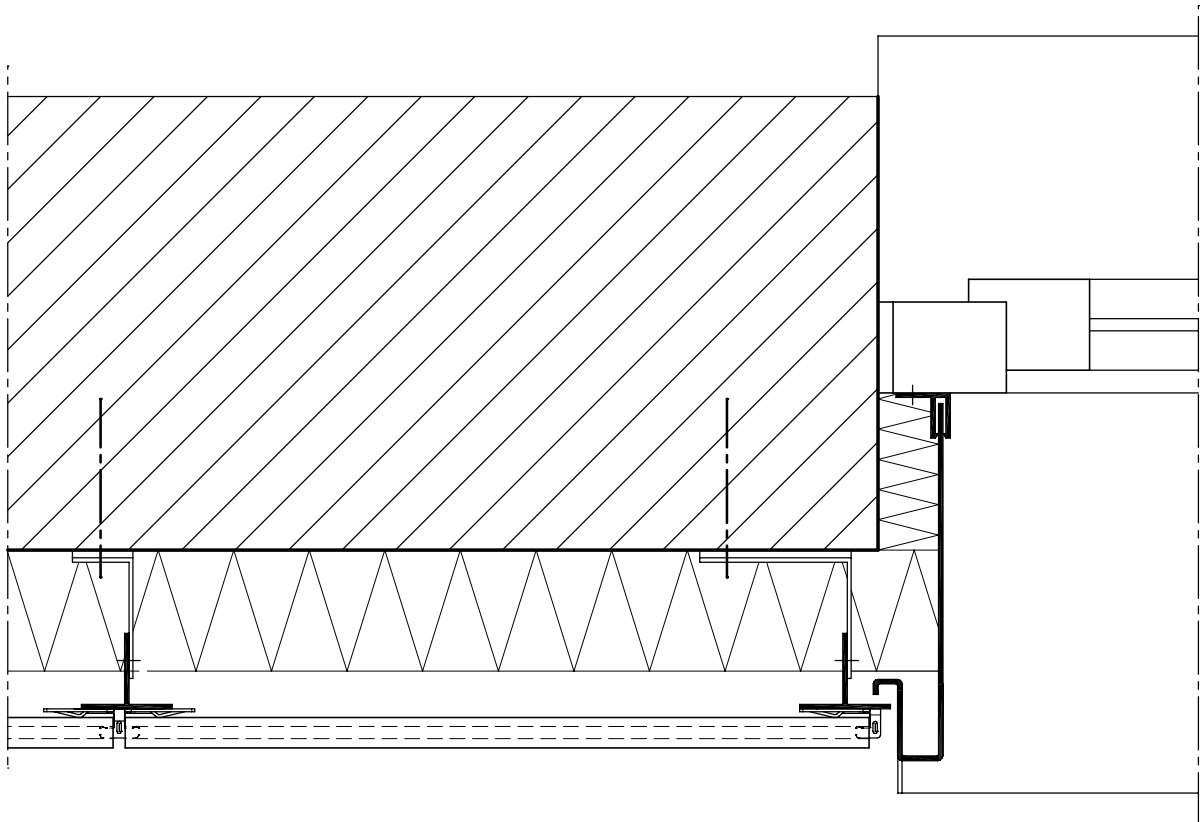

FENSTERLEIBUNG MIT KERATWIN

EMBRASURE OF THE WINDOW WITH KERATWIN
EMBRASURE DE FENETRE AVEC KERATWIN

KERATWIN K20 - KLAMMER

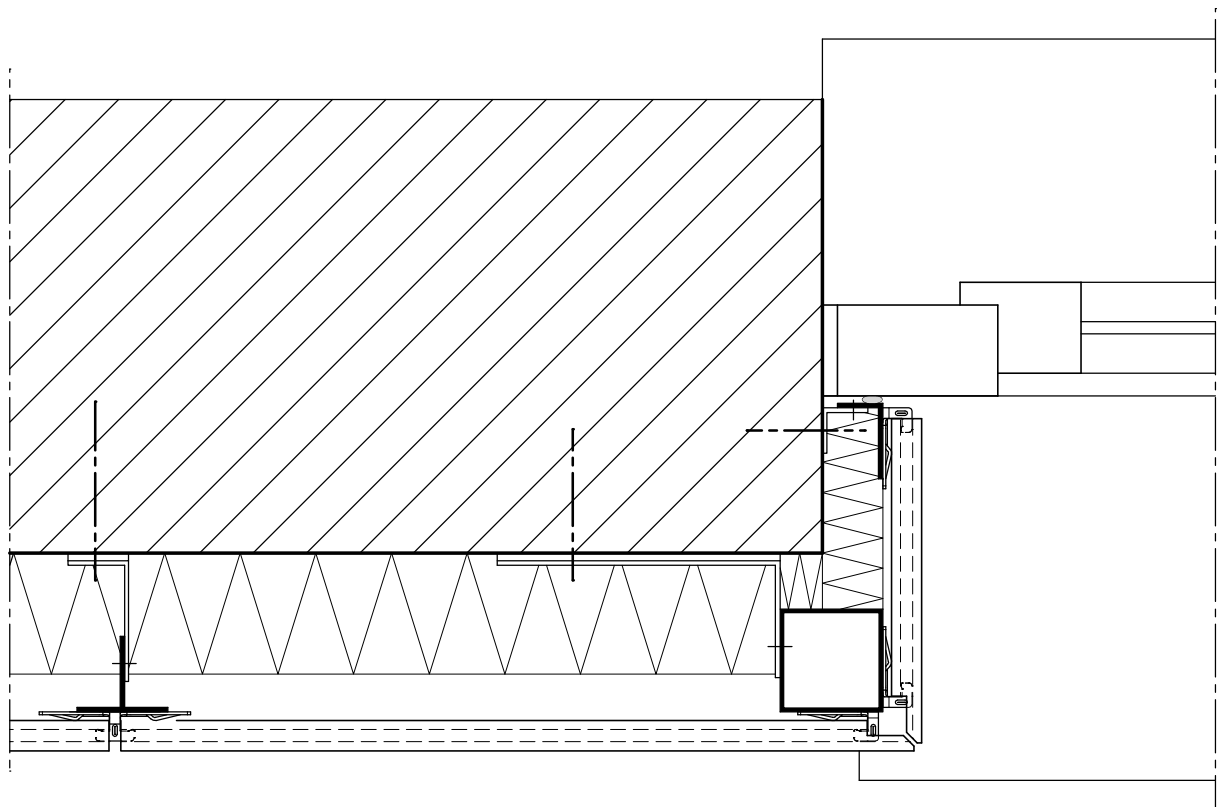

DACHABSCHLUSS

COVERING OF THE ROOF PARAPET
RECOUVREMENT D' ATTIQUE

KERATWIN K20 - KLAMMER

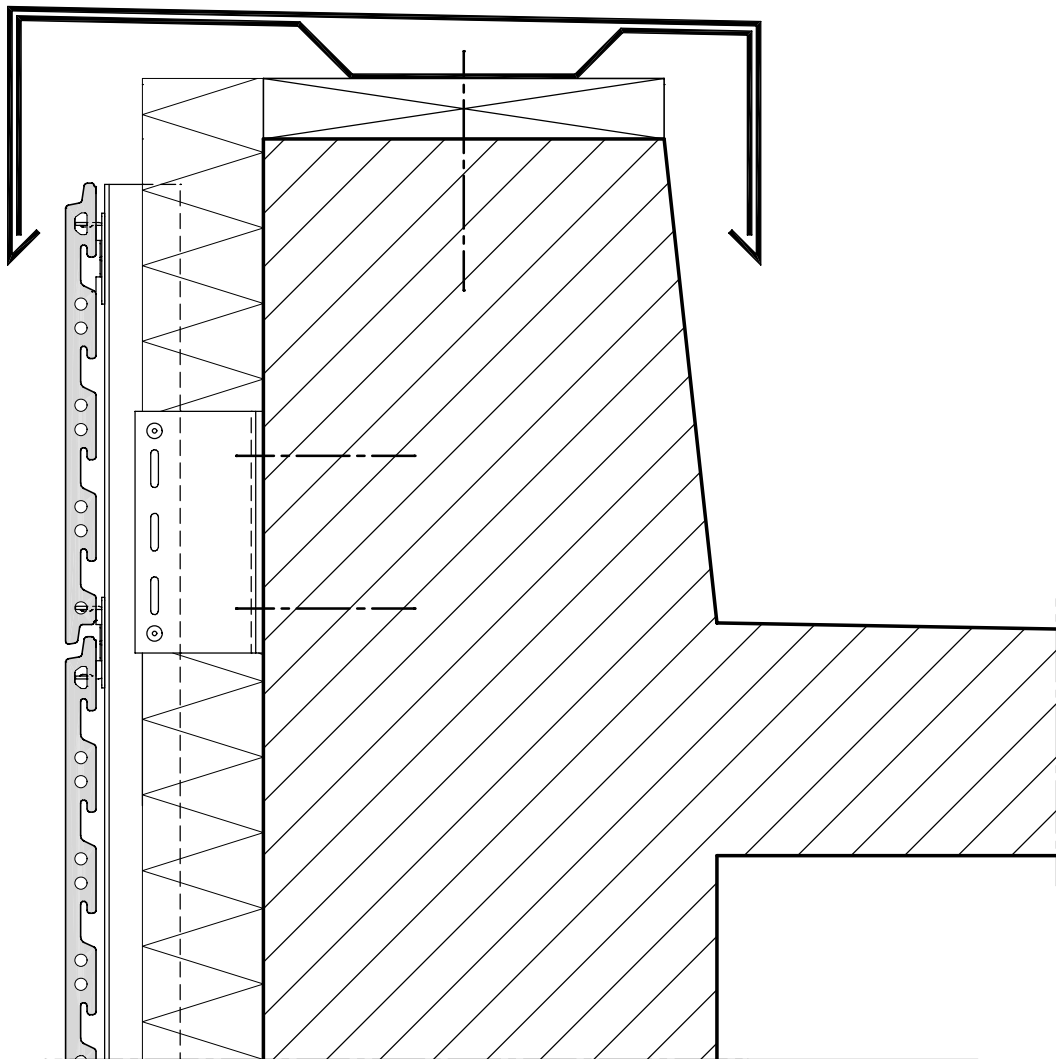

GESCHOSSAUSGLEICHSPROFIL

HEIGHT ADJUSTING PROFILE
PROFILÉ D'AJUSTEMENT DE NIVEAU

KERATWIN K20 - KLAMMER

